

Test Data Sheet

PM-Li6/7_L3

(old: EO-Li6/Li7L3-NIR)

S/N:

Double Resonance electro-optic phase modulator

with

- tunable resonance frequencies

- thermal crystal mount

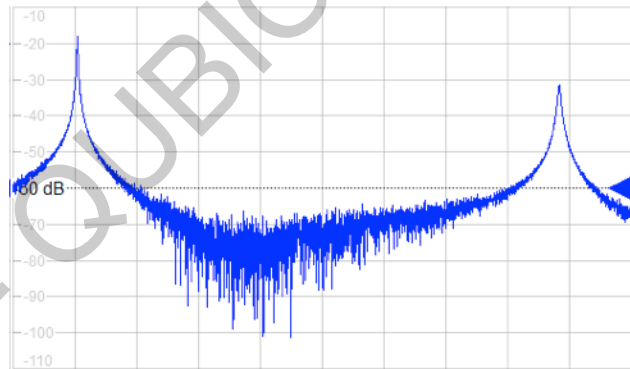
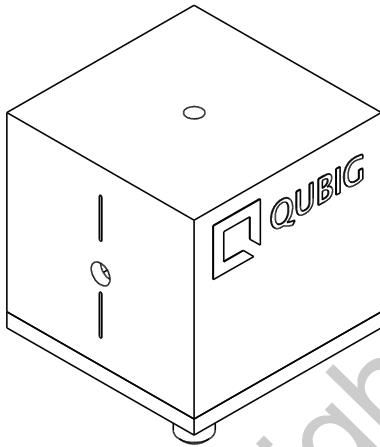

RF properties	R1	R2	Unit
Resonance frequency: f_0 ¹⁾	195-280	695-1023	MHz
Preset frequency: f_{set} ¹⁾	228	813	MHz
Bandwidth: $\Delta\nu$	1.2	3.5	MHz
Quality factor: Q	190	232	
Required RF power for 1rad @ 671nm ²⁾	24.6	30.1	dBm
max. RF power: RF_{max} ³⁾	2		W
Optical properties			
EO crystal	LN		
Aperture	3x3		mm ²
Wavefront distortion (633nm)	$\lambda/6$		nm
recommended max. optical intensity (671nm)	<1		W/mm ²
AR coating (R<0.5%)	630 - 1200		nm

¹⁾ at 24.3°C ²⁾ with 50Ω termination ³⁾ no damage with $RF_{in} < 3W$

Resonance characteristics of R1

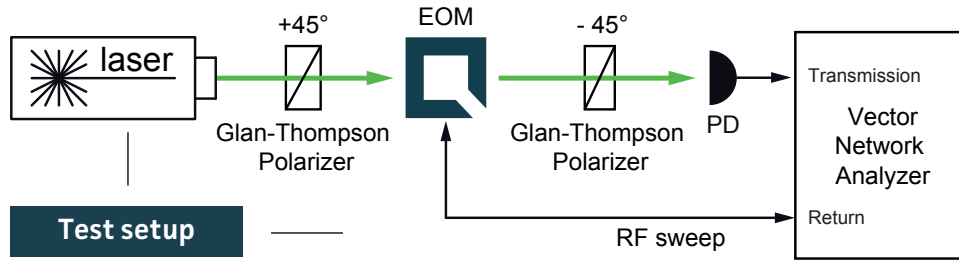

2/24/2017 12:56:34 PM
1328.5170K92-100178-XI

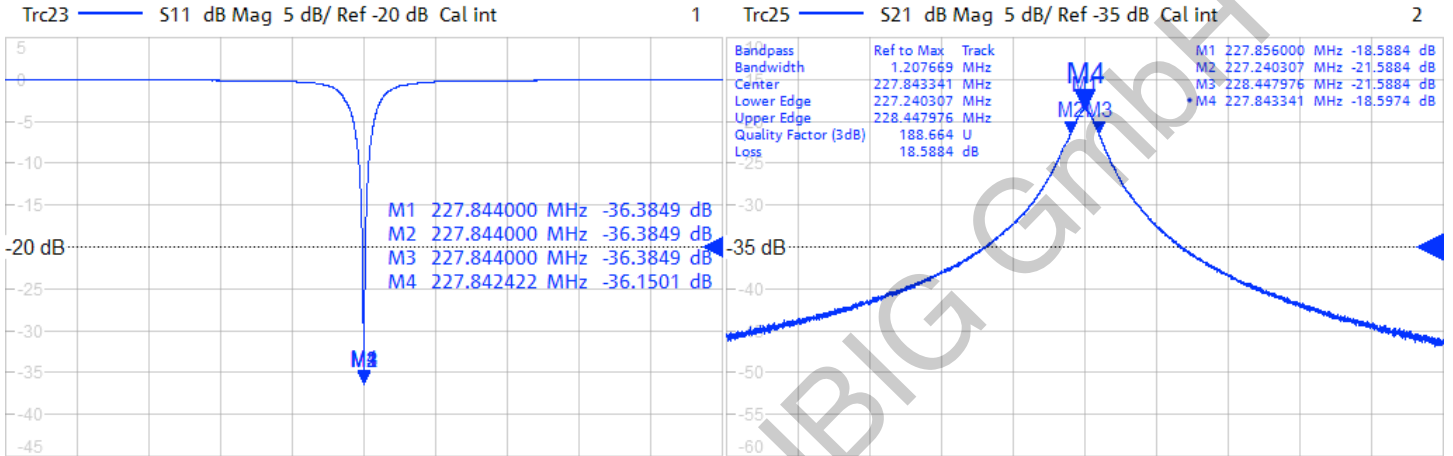

Ch1 Center 227.85 MHz Pwr 0 dBm Bw 10 kHz Span 30 MHz

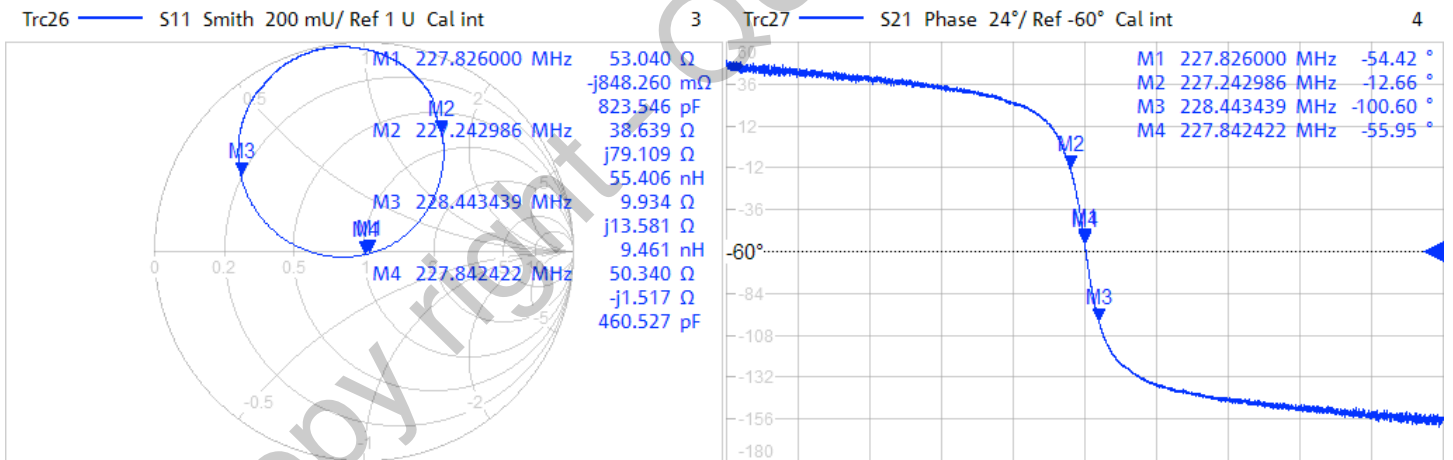

Ch1 Center 227.85 MHz Pwr 0 dBm Bw 10 kHz Span 30 MHz

Tuning performance of R1

MAX resonance frequency	f_0 max	280	MHz
MIN resonance frequency	f_0 min	195	MHz
number of turns	N_{max}	10	
counter clock-wise turns ☒	higher f_0 ↑		
clock-wise turns ☒	lower f_0 ↓		

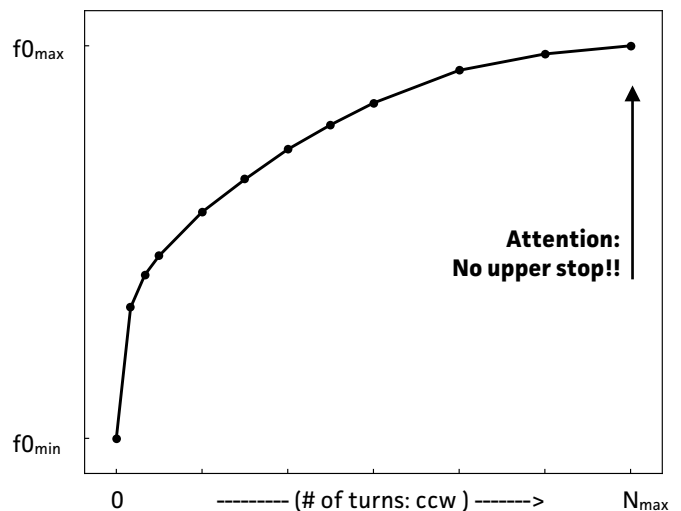

- actuate tuner **CAREFULLY** with supplied tuning tool
- tuner might not be perfectly perpendicular
- there might be no hard upper or lower stops (!)

Fig. 1: Oscilloscope trace

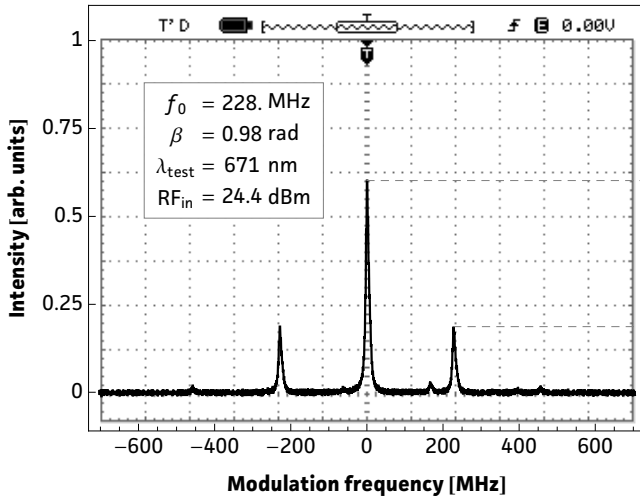

Fig. 2: Carrier/sideband ratio

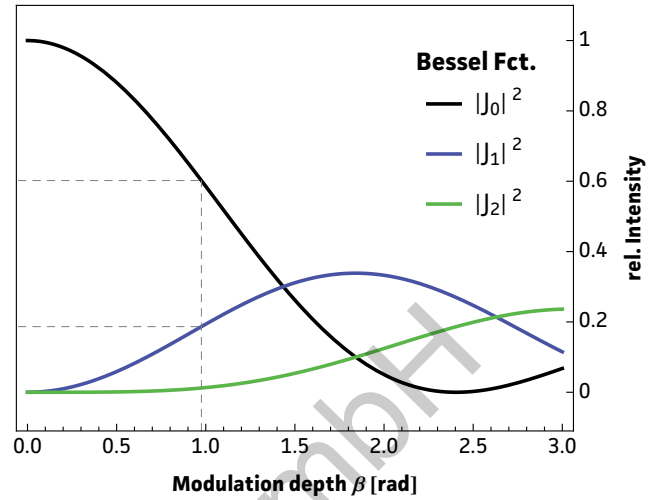

Table 1: Expected modulation

$\beta = 1 \text{ rad}$	unit	λ_1
λ	nm	671
P	dBm	24.6
P	mW	289
U	V _p	5.4
U _{π}	V _p	16.9
β / U	rad / V	0.19

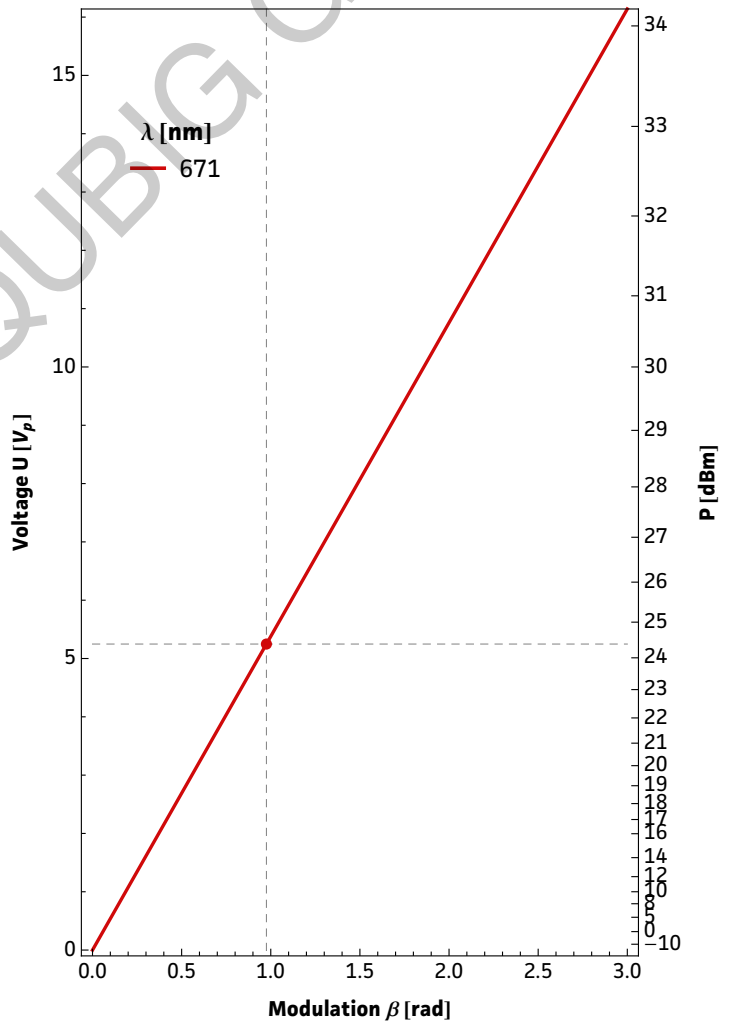

Fig.1: Recorded oscilloscope trace retrieved from a test setup as illustrated below.

Fig.2: Squared absolute values of first-kind Bessel functions vs. modulation depth. Vertical lines reveal the ratio between the carrier $|J_0|^2$ and the i^{th} sideband $|J_i|^2$ at a specific β .

Fig.3: Dependency between RF amplitude and modulation depth for different wavelengths. Points on the curve allow to retrieve either the required RF amplitude for a specific/desired β or the max. achievable modulation depth for a given/available RF power.

Table 1: Expected RF-amplitude/-power values and conversion factors for the required wavelength at the reference modulation depth of 1 rad. Note: Experimentally recorded modulation depth displayed in Fig.1 might vary from the respective values ($\beta=1\text{rad}$) provided in the table.

Fig. 3: RF-signal amplitude vs. modulation depth

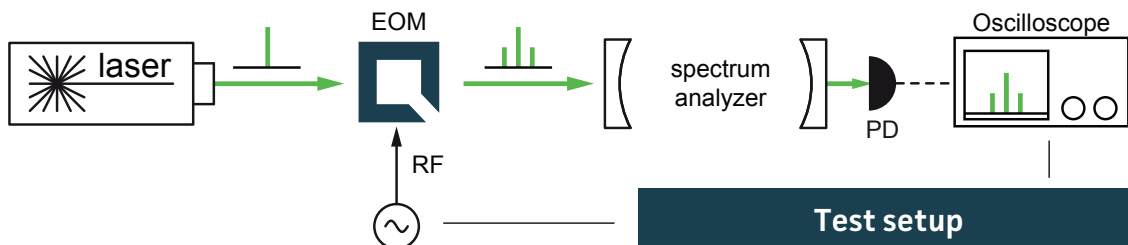

Resonance characteristics of R2

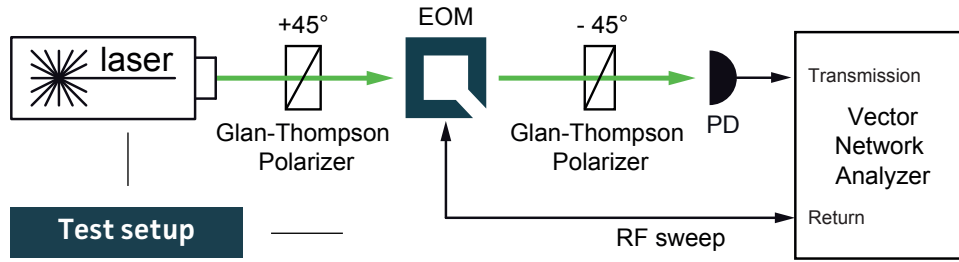

2/24/2017 1:01:36 PM
1328.5170K92-100178-XI

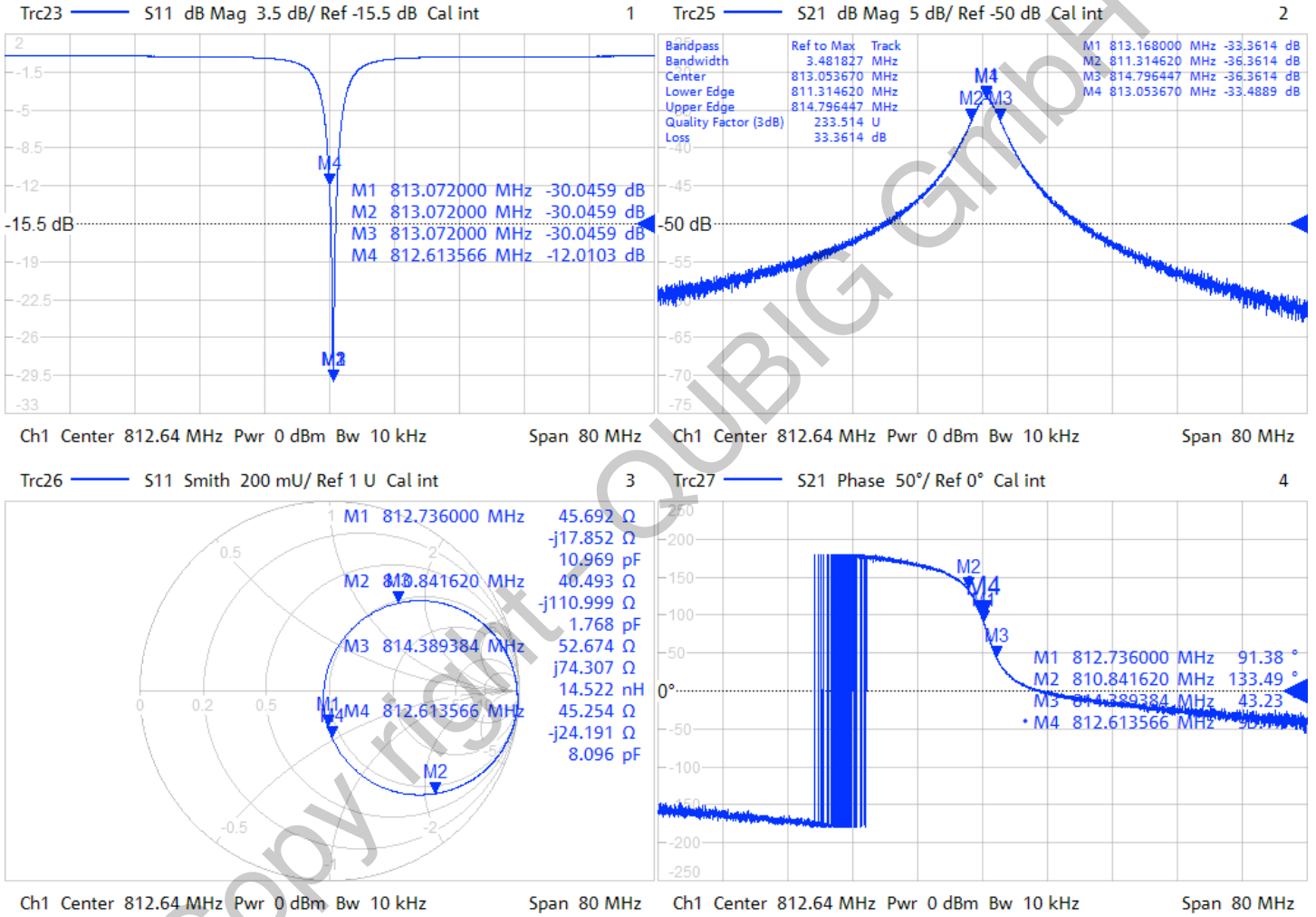

Tuning performance of R2

MAX resonance frequency	f_0 max	1023	MHz
MIN resonance frequency	f_0 min	695	MHz
number of turns	N_{max}	10	
counter clock-wise turns ☒	higher f_0 ↑		
clock-wise turns ☒	lower f_0 ↓		

- actuate tuner **CAREFULLY** with supplied tuning tool
- tuner might not be perfectly perpendicular
- there might be no hard upper or lower stops (!)

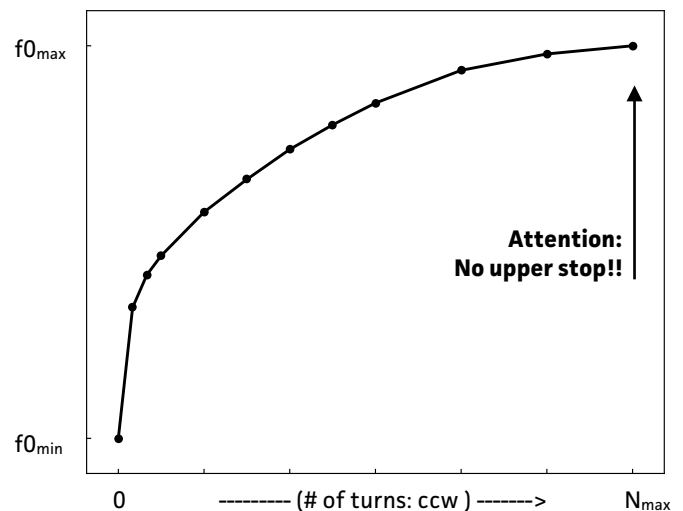

Fig. 1: Oscilloscope trace

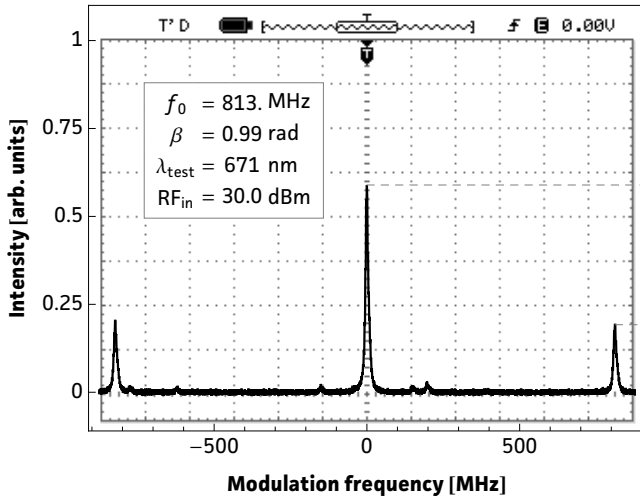

Fig. 2: Carrier/sideband ratio

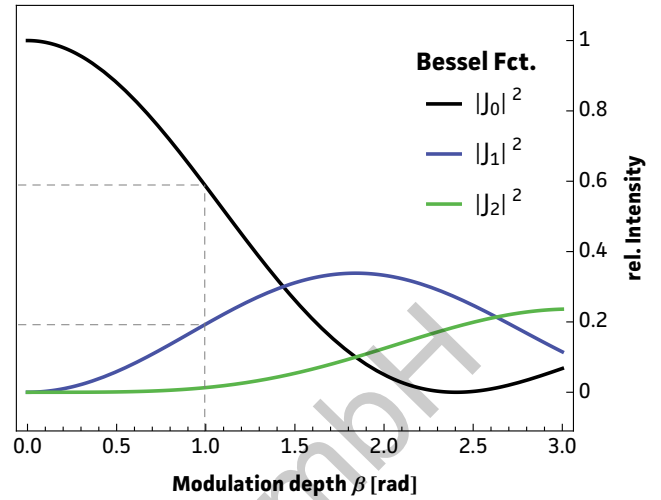

Table 1: Expected modulation

$\beta = 1$ rad	unit	λ_1
λ	nm	671
P	dBm	30.1
P	W	1.01
U	V _p	10.1
U _{π}	V _p	31.6
β / U	rad / V	0.1

Fig.1: Recorded oscilloscope trace retrieved from a test setup as illustrated below.

Fig.2: Squared absolute values of first-kind Bessel functions vs. modulation depth. Vertical lines reveal the ratio between the carrier $|J_0|^2$ and the i^{th} sideband $|J_i|^2$ at a specific β .

Fig.3: Dependency between RF amplitude and modulation depth for different wavelengths. Points on the curve allow to retrieve either the required RF amplitude for a specific/desired β or the max. achievable modulation depth for a given/available RF power.

Table 1: Expected RF-amplitude/-power values and conversion factors for the required wavelength at the reference modulation depth of 1 rad. Note: Experimentally recorded modulation depth displayed in Fig.1 might vary from the respective values ($\beta=1$ rad) provided in the table.

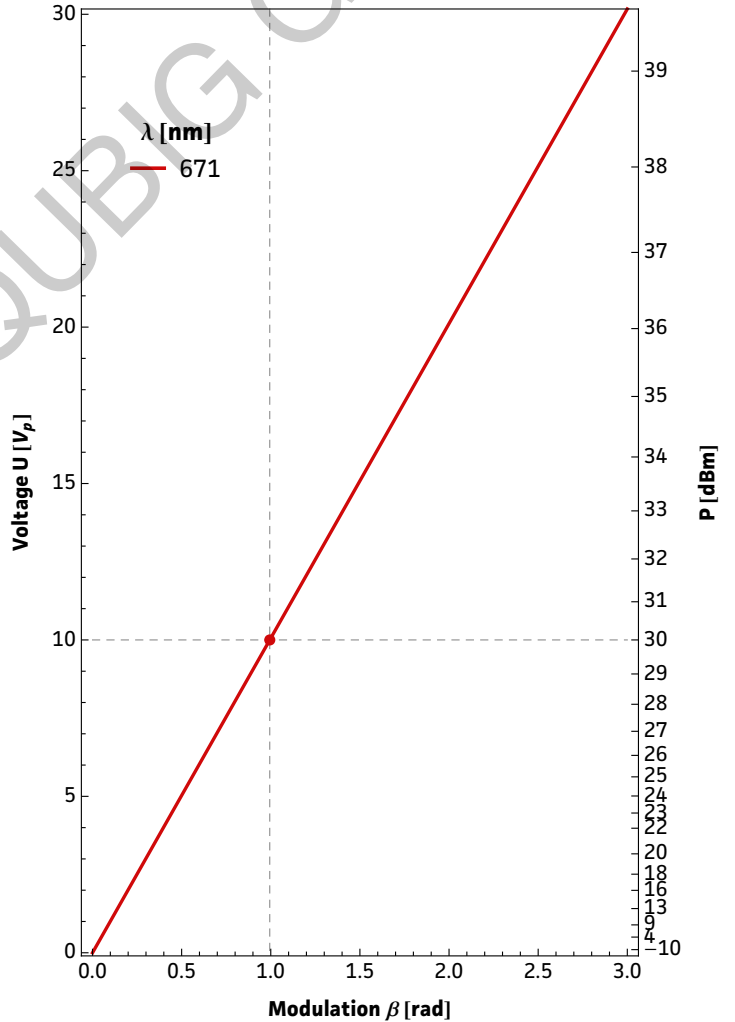
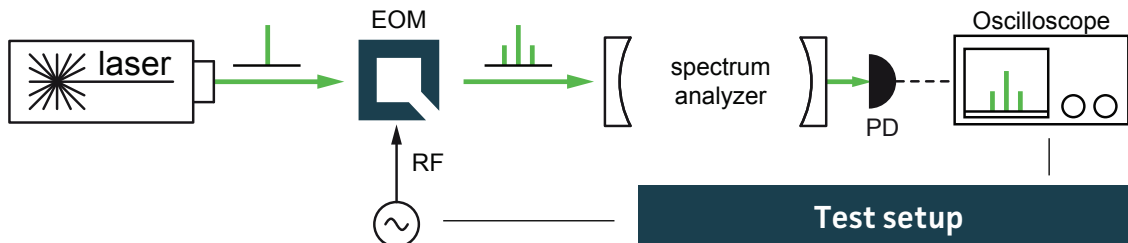

Fig. 3: RF-signal amplitude vs. modulation depth



Handling instructions

- Input laser polarization must be aligned with respect to the white markers on the housing
- Please handle device carefully. Avoid shock. Don't drop.
- After turn on the resonance frequency might drift slightly with applied RF power. Please compensate by tuning the RF drive frequency until steady-state (~min).
- Slight angle adjustment can reduce unwanted residual amplitude modulation (RAM)

Package drawing

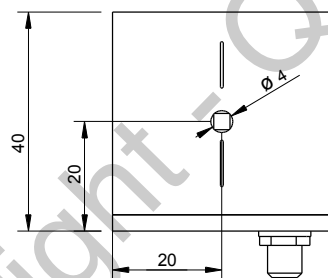
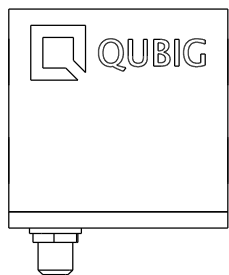
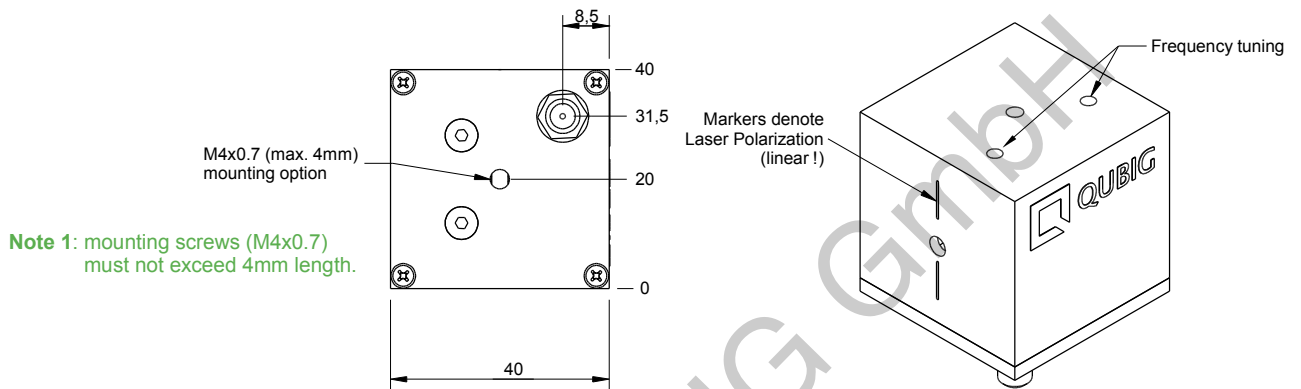

Use this side for heat sinking

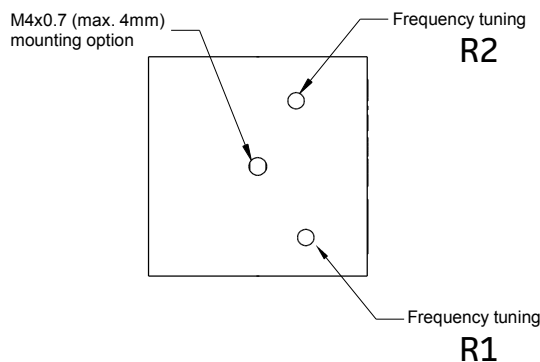
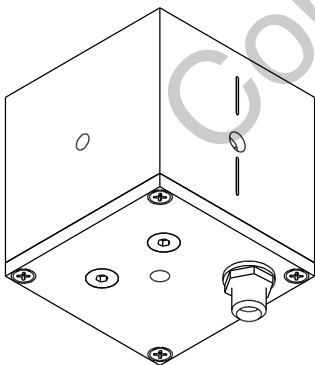
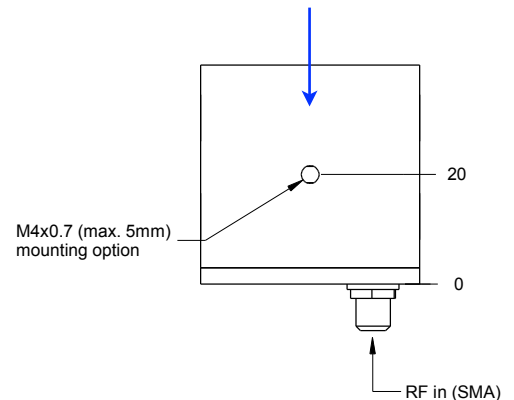

Attention!!

- use only supplied tuning tool
- actuate tuner carefully
- do not apply too much pressure or torque
- keep tuning tool coaxial
- tuner might not be perfectly orthogonal to box

Tested by:

Tel: +49 8642 2449064
 Fax: +49 8642 2447063
 eMail: mail@qubig.de
 web: www.qubig.com

Qubig GmbH
 Greimelstr. 26
 83236 Übersee
 Germany